

Abnormal Loads Dimensions and Weight



Please complete all dimensions using metric measurements:
Tonnes, Kilogrammes, Metres, Centimetres

Return to fax no. +45 98 42 27 50

Vehicle Number:

Route:

Date:

Time:

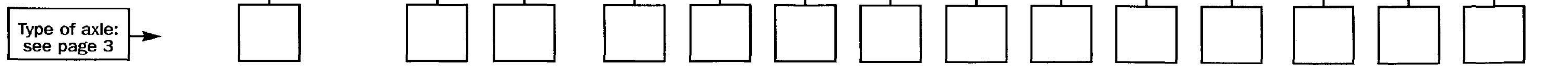
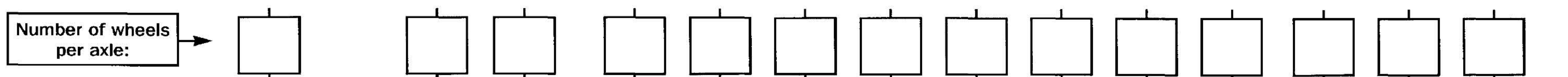
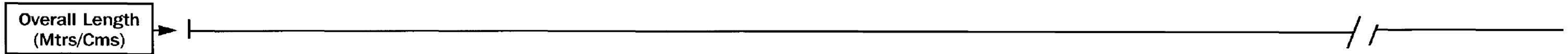
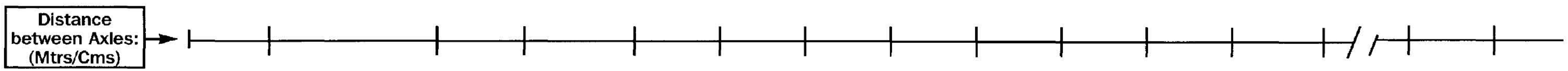
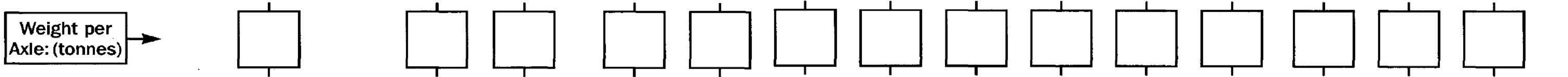
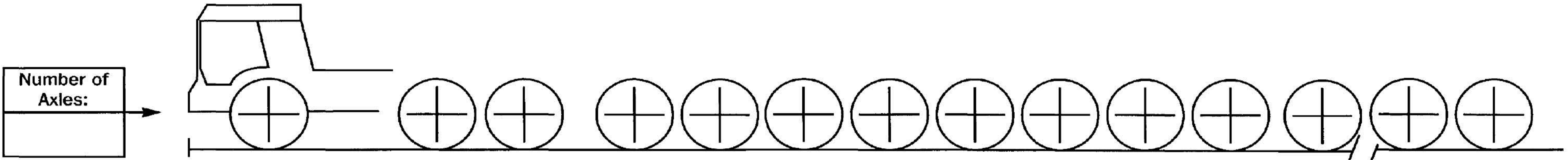

Overall Width: (metres/cms)	Max Height: (metres/cms)	Minimum Clearance: (metres/cms)	Total Movement Gross Weight: (kgs)
-----------------------------	--------------------------	---------------------------------	------------------------------------

Please confirm distances as below on the appropriate Axle type diagram

i.e. A= Tyre Width B= Axle Width C= Overall Width



VEHICLE / TRAILER NUMBER: _____

Axle type One

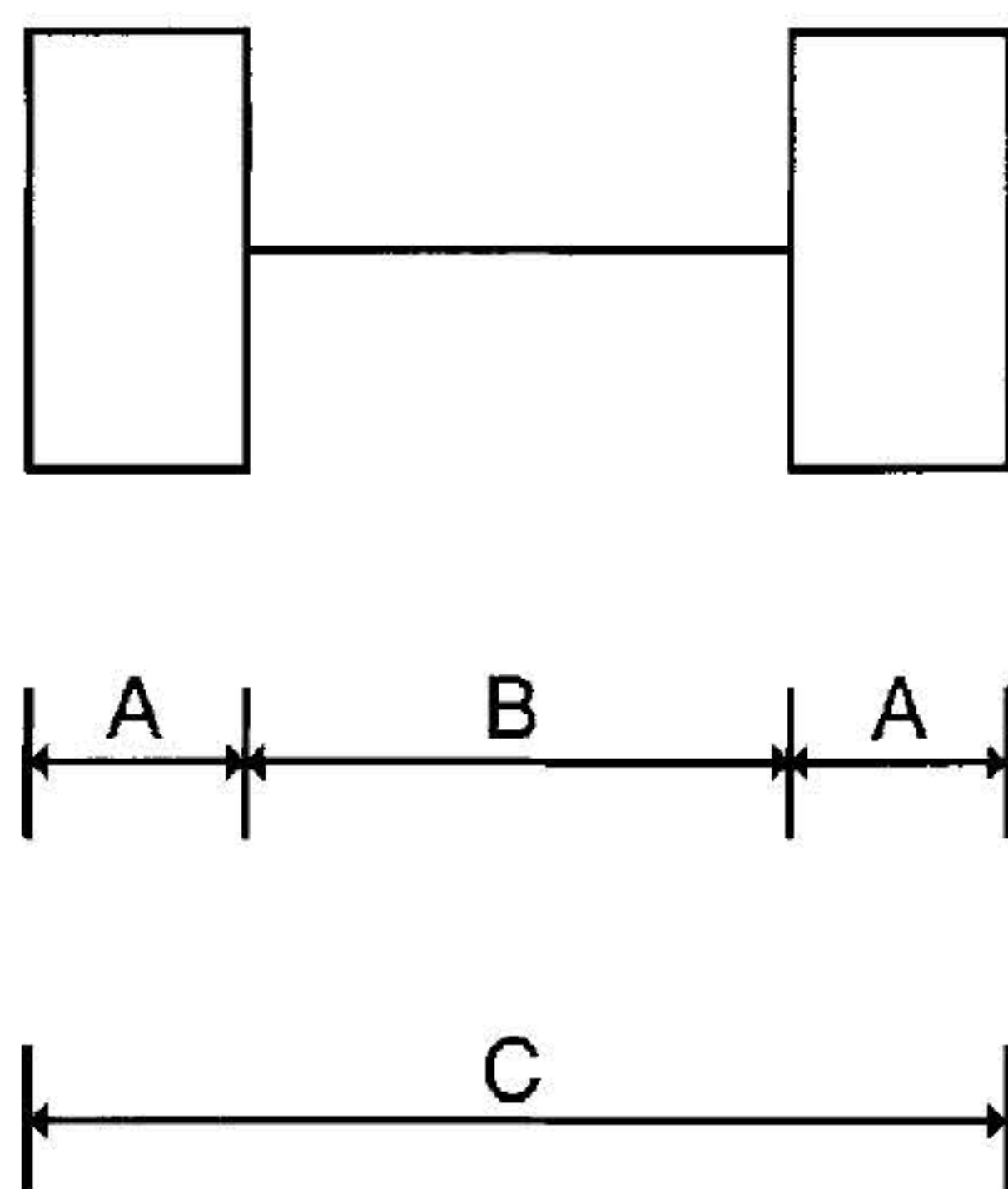

A=

B=

C=

Axle type Two

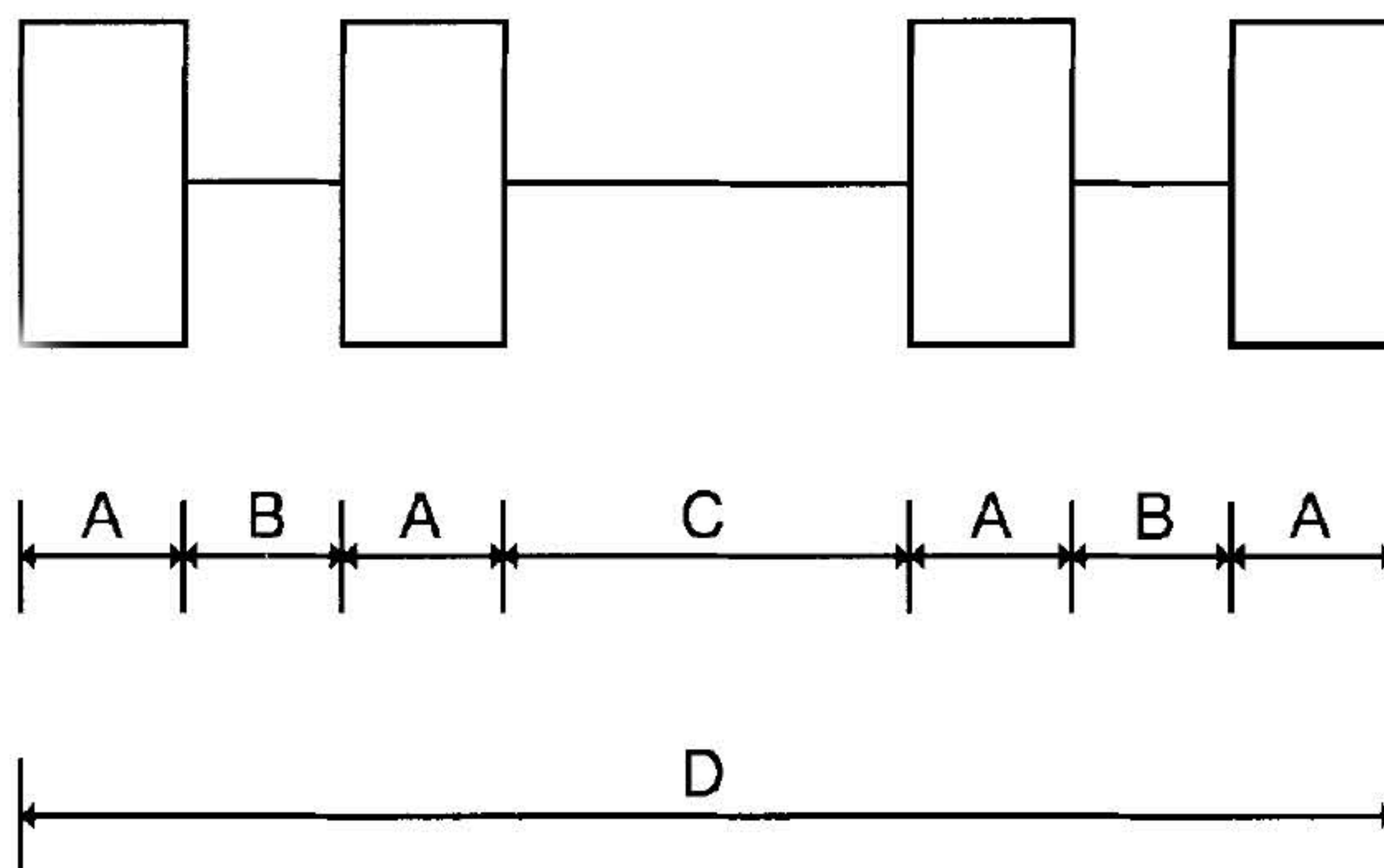

A=

B=

C=

D=

Axle type Three

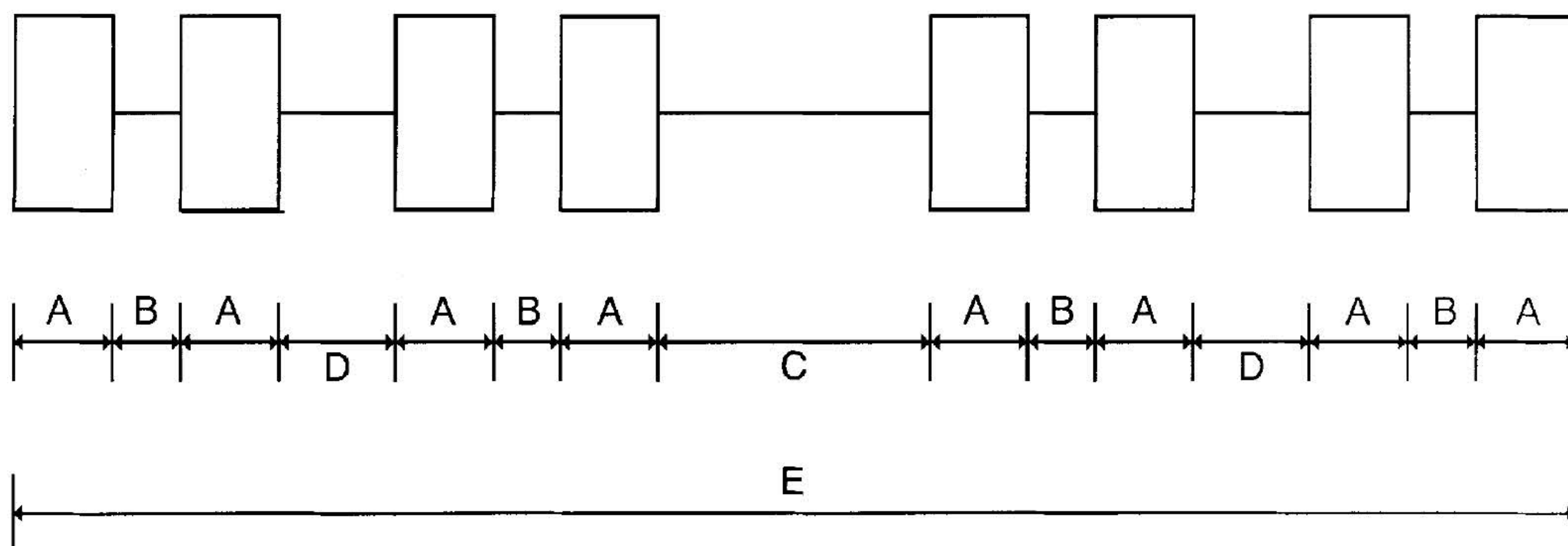

A=

B=

C=

D=

E=